

GRADALL®

XL 5300 V

HYDRAULIC EXCAVATOR



SPECIFICATIONS

Engine

- Volvo TAD571 VE, Tier 4f, 4 cycle, inline 4 cylinder, liquid cooled, electronic controlled
- Vertical canister style lube and main fuel filters and fuel/water separation with manual feed pump attached to engine
- Water in fuel indicator and alarm

Gross Rating: 173 hp @ 2200 rpm (129kW)
590 ft lb torque @ 1100-1500 rpm (800Nm)

Net Rating: 153 hp @ 2200 rpm (114kW)

- Variable viscous fan clutch system
- Vertical stacked hydraulic oil cooler, charge air cooler and radiator

Maximum slope: 30°

- 24 volt starter
- 100 amp alternator
- Two SAE #C31-S 1000 CCA batteries
- Two-stage air cleaner with high-efficiency pre-cleaner
- Vacuator valve
- Remote service indicator.

Fuel tank capacity: 99 gal (375 L)

Operator Cab

- All-weather cab
- Tinted safety glass windows
- Skylight
- Acoustical lining
- Four-way adjustable seat
- AM/FM radio
- Filtered fresh air heater
- Defroster
- Air conditioning
- Front window slides to overhead storage
- Mirrors on right and left sides
- Seat belt
- Windshield wiper and washer
- LED high/low beam headlights
- LED parking lights
- LED brake lights
- LED four-way hazard lights
- LED turn indicator lights
- LED work lights
- LED swing lights
- Axle oscillation lock switch

Controls

- Two electronic joysticks (hoist and bucket, telescope and swing)
- One rocker switch (tilt) control
- Joysticks mounted on arm pods
- Quick change joystick pattern switch (Gradall, SAE, Deere)
- Self-centering joysticks and pedals; when controls are released, power for movement disengages and swing and tilt brake set automatically
- Tilting/telescoping steering column
- Hydraulic foot pedal controls braking functions
- Travel speed is regulated with an electronic foot pedal control
- Switch on the FWD/REV selector provides 1st/2nd gear selection
- Independent rocker switches control stabilizers, axle oscillation, park brake and hazard lights
- Switch on column provides marker lights, high/low headlights and direction indicators

Engine Controls and Instrumentation

- Key ignition/starter switch; throttle and main battery disconnect switch
- Air cleaner condition indicator
- Electronic monitor indicates fuel level, low battery charge, lube oil pressure, high coolant temperature, engine rpm and engine hours
- Fuel saving auto idle feature sends engine rpm to idle when control circuits are in neutral for seven seconds

Boom

- Two piece triangular telescoping boom
- Adjustable boom rollers with eccentric shafts
- 220° boom tilt
- 105° boom pivot angle

Hydraulic System

Pumps

- One load-sensing, axial piston pump; oil flow 0-110 gpm (0-416 L/min)
- Tandem gear pump (steering, brake/pilot) 10 gpm (38 L/min), 6 gpm (23 L/min)

System Monitor

- Electronic monitor in cab indicates
 - Low hydraulic fluid level
 - High hydraulic fluid temperature
 - System working pressure
 - System pilot pressure

SYSTEM SPECIFICATIONS

Six Cylinders

- One tool cylinder: 5.0" ID, 3.0" rod (127 mm x 76 mm), 25.9" (658 mm) stroke
- Two hoist cylinders: 4.75" ID, 3.35" rod (121 mm x 85 mm), 31.0" (787 mm) stroke
- One telescope: 3.75" ID, 2.75" rod (95 mm x 70 mm), 14' (4.27 m) stroke
- Two single-acting axle oscillation cylinders 4.528" ID, 4.528" rod (115 mm x 115 mm), 6.25" (159 mm) stroke

Three Hydraulic Motors

- Swing, 68 hp (51 kW)
- Tilt, 21 hp (16 kW)
- Propel, 113 hp (84 kW)

Operating Pressures:

- Hoist.....4,900 psi (331 BAR)
- Tilt.....2,500 psi (172 BAR)
- Swing.....4,500 psi (310 BAR)
- Tool.....4,900 psi (331 BAR)
- Telescope.....4,900 psi (331 BAR)
- Propel.....4,900 psi (331 BAR)
- Pilot System.....550 psi (38 BAR)
- Braking & Steering.....2,400 psi (165 BAR)
- Blade & Stabilizers.....4,000 psi (207 BAR)

Oil Capacity

- Reservoir system 65 gallons (246 L)
- Pressurized reservoir with visual oil level gauges

Filtration System

- 10 micron return filter
- 10 micron pilot filter
- Fin and tube-type oil cooler with thermal by-pass and relief valves
- Pressure-compensated, load-sensing valves with circuit reliefs in all circuits

Undercarriage

- Full-time 4-wheel drive transfer case delivers power from the hydraulic drive motor to the drive axles
- Both axles equipped with internal wet-disc type service brakes
- Steering axle fitted with oscillation lock cylinders
- Optional stabilizer or blade

Tires: 10.00 x 20 Super-Lug

Axles: ZF Model 3070 (FTF 2090)

Transmission: ZF Model HL 290

Drive Motor: Rexroth A6 Series, 160cc/Rev

Minimum Turning Radius: 25'5" (7.75 m)

Undercarriage Drive

- Variable displacement high torque piston motor powers two-speed power shift transmission
- Speed mode selection can also be done while moving
- Electronically operated travel alarm signals excavator movement

Gradeability

- 58%, limited by engine lubrication requirements

Tractive Effort

- 27,661 (123kN)

Travel speed on flat, level surface—mph km/hr:

	Creep Mode	Standard Mode
First Gear	1.3 mph (2.1 kmh)	4.0 mph (6.5 kmh)
Second Gear	4.7 mph (7.6 kmh)	15.0 mph (24.1 kmh)

Swing

- Priority swing circuit with axial piston motor
- Planetary transmission

Swing speed: 7.0 rpm

Swing Brake

- Automatic spring-set/hydraulic release wet disc parking brake
- Dynamic braking provided by the hydraulic system

Function Forces

Rated Bucket Breakout Force:

25,405 lb (113 kN).

Rated Boom Force: 24,941 lb (111 kN).

Weight

- Approximate working weight with 36" (914 mm) excavating bucket, fuel tank half full - 51,216 lb (23,231 kg)

Outriggers: 2,720 lb (1,234 kg)

Blade: 1,529 lb (694 kg)

GRADALL Model XL 5300 V Excavator Rated Lift Capacity - LB (KG)

LOAD POINT HEIGHT		LOAD RADIUS										
		10' (3.0 m)		15' (4.6 m)		20' (6.1 m)		25' (7.6 m)		Maximum Radius		
		Over End	Over Side	Over End	Over Side	Over End	Over Side	Over End	Over Side		Over End	Over Side
Above Ground Level	20' (6.1 m)							5900 (2675)	5900 (2675)	27'3" (8.3 m)	5270 (2390)	5270 (2390)
	15' (4.6 m)			12730 (5775)	12730 (5775)	9045 (4105)	9045 (4105)	6725 (3050)	6725 (3050)	29'4" (8.9 m)	5320 (2415)	5320 (2415)
	10' (3.0 m)					10180 (4620)	10180 (4620)	7375 (3345)	7375 (3345)	30'5" (9.3 m)	5430 (2465)	5430 (2465)
	BOOM LEVEL 8'6" (2.6 m)					10405 (4720)	10405 (4720)	7510 (3405)	7510 (3405)	30'7" (9.3 m)	5470 (2480)	5470 (2480)
	5' (1.5 m)					10625 (4820)	10625 (4820)	7675 (3480)	7675 (3480)	30'7" (9.3 m)	5580 (2530)	5580 (2530)
At Ground Level						10165 (4610)	10165 (4610)	7535 (3420)	7535 (3420)	29'11" (9.1 m)	5760 (2615)	5760 (2615)
Below Ground Level	5' (1.5 m)			11520 (5225)	11520 (5225)	9040 (4100)	9040 (4100)	7015 (3180)	7015 (3180)	28'4" (8.6 m)	5955 (2700)	5955 (2700)
	15' (4.6 m)	8825 (4005)	8825 (4005)	8980 (4075)	8980 (4075)	7670 (3480)	7670 (3480)	6265 (2840)	6265 (2840)	25'6" (7.8 m)	6125 (2780)	6125 (2780)
	10' (3.0 m)	6085 (2760)	6085 (2760)	6930 (3145)	6930 (3145)	6345 (2880)	6345 (2880)			21'1" (6.4 m)	6155 (2790)	6155 (2790)
	20' (6.1 m)									13'3" (4.0 m)	5180 (2350)	5180 (2350)

NOTE: The above loads are in compliance with the SAE standard J1097 DEC2005. They do not exceed 87% of hydraulic lifting capacity or 75% of tipping capacity.

The rated lift capacity is based on the machine being equipped with 15,000 lb (7,030 kg) counterweight, standard boom, standard tires, no auxiliary hydraulics and no bucket.

NOTE: Bucket adjustment values are 87% of the actual bucket weights.

The load point is located on the bucket pivot point, including loads listed for maximum radius.

Do not attempt to lift or hold any load greater than these rated values at specified load radii and heights. The weight of slings and any auxiliary devices must be deducted from the rated load to determine the net load that may be lifted.

ATTENTION: All rated loads are based on the machine being stationary and level on a firm supporting surface. The user must make allowance for particular job conditions such as soft or uneven ground, out of level conditions, side loads, hazardous conditions, experience of personnel, etc. The operator and other personnel must read and understand the operator manual before operating this machine. Rules for safe operation of equipment must be adhered to at all times.

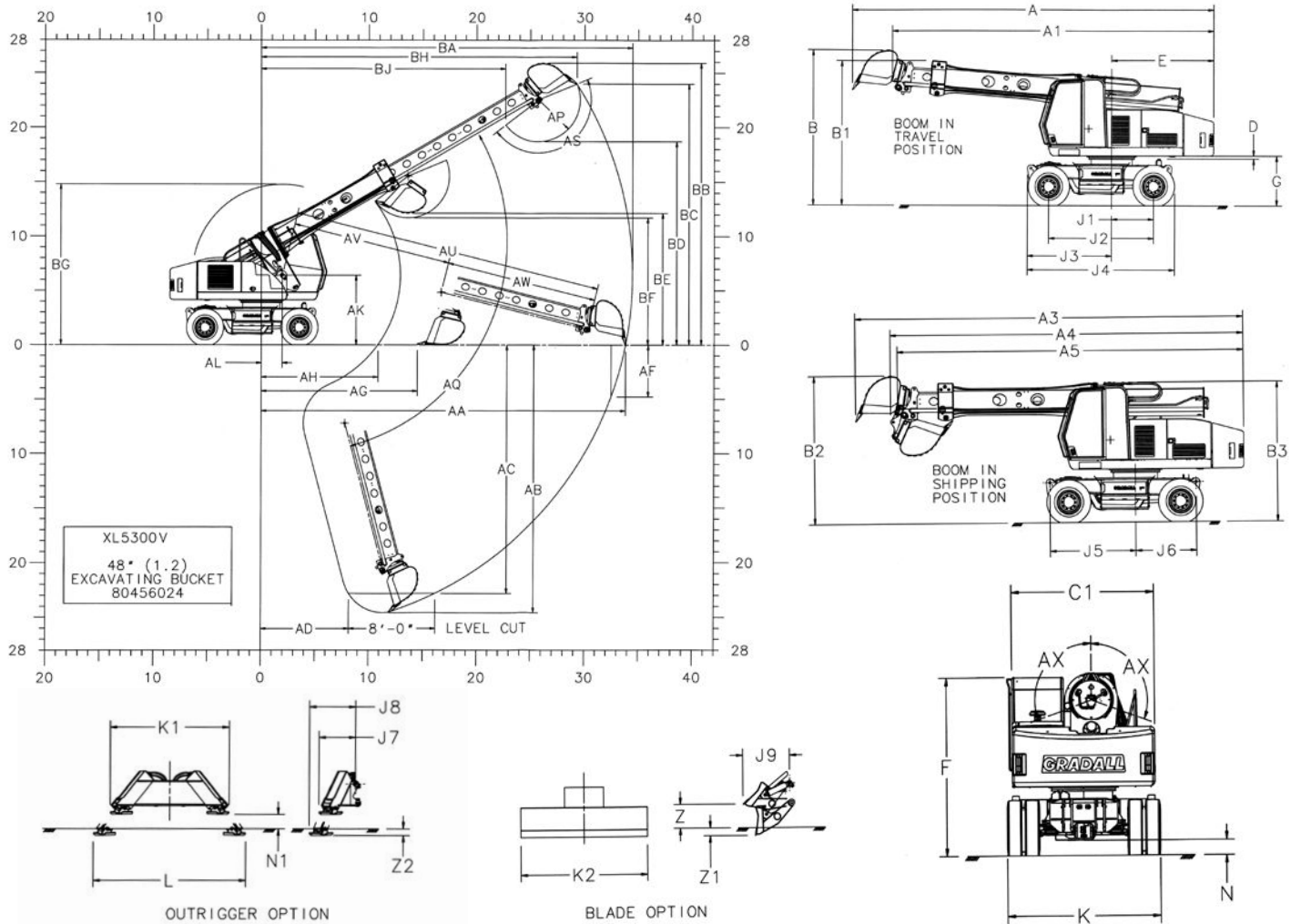

Dimensions

- A** Overall length with bucket open (travel position): 30'2" (9.2)
- A1** Overall length without bucket (travel position): 26'10" (8.2)
- A3** Overall length with bucket open (shipment position): 30'5" (9.3)
- A4** Overall length with bucket closed (shipment position): 27'8" (8.4)
- A5** Overall length without bucket (shipment position): 27'2" (8.3)
- B** Overall height with bucket open (travel position): 12'11" (3.9)
- B1** Overall height without bucket (travel position): 12'0" (3.7)
- B2** Overall height with bucket open (shipment position): 11'6" (3.5)
- B3** Overall height without bucket (shipment position): 10'11" (3.3)
- C1** Width of upperstructure: 8'6" (2.6)
- D** Minimum clearance, upperstructure to undercarriage: 3" (78 mm)
- E** Swing clearance, rear of upperstructure: 8'6" (2.6)
- F** Top of cab to groundline: 10'7" (3.2)
- G** Clearance, upperstructure to groundline: 4'2" (1.3)
- J1** Axis of rotation to centerline of fixed axle: 3'6" (1.1)
- J2** Wheelbase of undercarriage: 8'9" (2.7)
- J3** Axis of rotation to front of undercarriage: 7'0" (2.1)
- J4** Nominal overall length of undercarriage: 12'3" (3.7)
- J5** Axis of rotation to front option attachment pin: 6'9" (2.1)
- J6** Axis of rotation to rear option attachment pin: 4'9" (1.4)
- J7** Outrigger length, attachment pin to pad in up position: 2'7" (0.8)
- J8** Outrigger length, attachment pin to pad in down position: 3'3" (1.0)
- J9** Blade length, attachment pin across blade in up position: 3'4" (1.0)
- K** Overall width undercarriage 9'1" (2.8)
- K1** Overall width outrigger (up position): 8'4" (2.5)
- K2** Overall width blade: 9'0" (2.7)
- L** Overall width outrigger (down position): 10'8" (3.3)
- N** Ground clearance (per SAE J1234): 11" (275 mm)
- N1** Ground clearance (outrigger option): 12" (300 mm)
- Z** Blade above ground (option): 1'8" (505 mm)
- Z1** Depth below ground level of blade (option): 7" (166 mm)
- Z2** Depth below ground level of outrigger (option): 6" (142 mm)
- AA** Maximum radius at groundline: 33'10" (10.3)
- AB** Maximum digging depth: 24'7" (7.5)
- AC** Maximum depth for 8' level cut: 22'10" (7.0)
- AD** Minimum radius of 8' level cut at depth "AC": 8'2" (2.5)
- AF** Maximum depth of vertical wall which can be excavated: 4'9" (1.5)
- AG** Minimum level cut radius with bucket flat on groundline: 14'5" (4.4)
- AH** Minimum radius at groundline: 10'10" (3.3)
- AK** Boom pivot to groundline: 6'5" (2.0)
- AL** Boom pivot to axis of rotation: 1'11" (585 mm)
- AP** Bucket tooth radius: 3'10" (1.2)
- AQ** Boom pivot angle: 30° up and 75° dn
- AS** Bucket pivot angle: 165°
- AU** Maximum telescoping boom length (boom pivot to bucket pivot): 28'8" (8.7)
- AV** Minimum telescoping boom length (boom pivot to bucket pivot): 14'8" (4.5)
- AW** Telescoping boom travel: 14'0" (4.3)
- AX** Bucket tilt angle (both sides of center): 110°
- BA** Maximum radius of working equipment: 34'5" (10.5)
- BB** Maximum height of working equipment: 25'11" (7.9)
- BC** Maximum bucket tooth height: 24'0" (7.3)
- BD** Minimum clearance of bucket teeth, with bucket pivot at maximum height: 18'8" (5.7)
- BE** Minimum clearance of fully curled bucket at maximum boom height: 12'2" (3.7)
- BF** Minimum clearance of bucket teeth at maximum boom height: 11'8" (3.6)
- BG** Maximum height of working equipment with bucket below groundline: 14'9" (4.5)
- BH** Radius of bucket teeth at maximum height: 29'3" (8.9)
- BJ** Minimum radius of bucket teeth at maximum bucket pivot height: 22'8" (6.9)

Specifications subject to change without notice.
Metric units are meters (m) unless noted.
Machines shown may have optional equipment.

Optional Equipment

- Vandalism protection kit including window covers
- Strobe light
- Block heater
- ROPS protective cab
- Auxiliary hydraulics: Additional hosing and piping for hydraulic powered attachments. (Maximum pressure 4900 psi (331 BAR) Maximum flow 30 gpm (114 L/min))

Attachments

- Quick change and reversible buckets fabricated using steel plate with high strength, low alloy cutting edges and wear strips
- Standard attachments available for wide range of applications
- Capacities shown are in heaped cubic yard



Excavating Bucket

		yd ³	m ³
8045-6020	24" (610mm) 603 lbs (274 kg)	3/8	0.31
8045-6021	30" (762 mm) 660 lbs (300 kg)	1/2	0.41
8045-6022	36" (914mm) 741 lbs (336 kg)	5/8	0.54
8045-6023	42" (1.07m) 841 lbs (382 kg)	3/4	0.64
8045-6024	48" (1.22m) 957 lbs (434 kg)	1	0.76
8065-6117	48" (1.5 m) 959 lbs (435 kg)	1.5	1.15

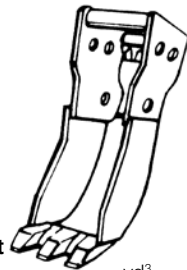

Trenching Bucket

		yd ³	m ³
8065-6104	15" (381mm) 897 lbs (407 kg)	1/5	0.15
8065-6012	21" (533mm) 982 lbs (445 kg)	1/4	0.19

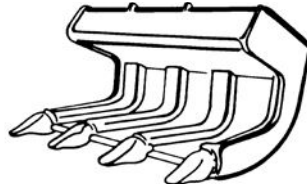

Pavement Removal Bucket

8065-6102	40" (1.0 m) 1262 lbs (573 kg)		
8065-6115	18" (0.457 m) 929 lbs (421 kg)		
8065-6116	24" (0.610 m) 1,219 lbs (553 kg)		
8065-6114	28" (0.711 m) 1,310 lbs (594 kg)		

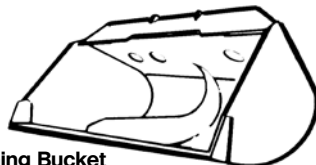

Ditching Bucket

		yd ³	m ³
8065-6040	30" 521 lbs (236 kg)	3/8	0.3
8065-6007	60" (1.52m) 807 lbs (366 kg)	7/8	0.73
8065-6006	66" (1.68m) 892 lbs (405 kg)	1	0.76
8065-6118	72" (1.6m) 1148 lbs (521 kg)	1.6	1.22
8065-6002	72" (1.83m) 944 lbs (428 kg)	1 1/8	0.87



Dredging Bucket

		yd ³	m ³
8065-6013	72" (1.83m) 1114 lbs (505 kg)	1 1/8	0.87

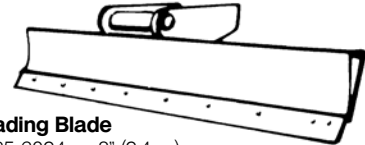

Grading Blade

8065-6024	8" (2.4 m) 630 lbs (285 kg)		
-----------	--------------------------------	--	--

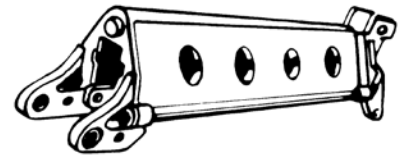

Boom Extension

8065-5028	4' (1.2 m) 1,090 lbs (495 kg)		
8065-5029	6' (1.8 m) 1,250 lbs (560 kg)		
8065-5030	8' (2.4 m) 1,389 lbs (631 kg)		
8065-5031	12' (3.7 m) 1670 lbs (759 kg)		

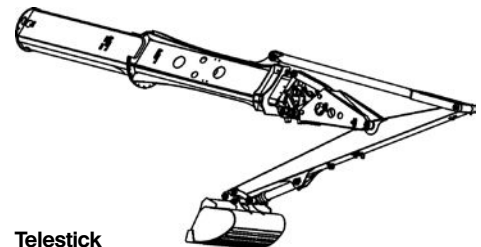

Telestick

8055-5007	3,600 lbs (1,633 kg)		
-----------	----------------------	--	--

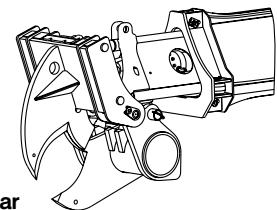

Tree Limb Shear

8045-5052	1,948 lbs (884 kg)		
-----------	--------------------	--	--

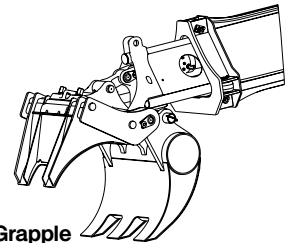

Fixed Thumb Grapple

8075-5023	1,574 lbs (714 kg)		
-----------	--------------------	--	--

It is Gradall Policy to continually improve its products. Therefore designs, materials and specifications are subject to change without notice and without incurring any liability on units already sold. Units shown may have optional equipment.

GRADALL®

406 Mill Ave. SW, New Philadelphia, Ohio 44663
Phone: 800-445-4752 Fax: 330-339-8468
www.Gradall.com

Certified ISO 9001



Form No. 11823 6/18
Printed in USA